

Chapter 5

Treatment Machines for External Beam Radiotherapy

This set of 126 slides is based on Chapter 5 authored by
E.B. Podgorsak
of the IAEA publication (ISBN 92-0-107304-6):

**Radiation Oncology Physics:
A Handbook for Teachers and Students**

Objective:

To familiarize students with basic principles of equipment used for external beam radiotherapy.



Slide set prepared in 2006 (updated Aug2007)
by E.B. Podgorsak (McGill University, Montreal)
Comments to S. Vatnitsky:
dosimetry@iaea.org

CHAPTER 5. TABLE OF CONTENTS

- 5.1. Introduction
- 5.2. X-ray beams and x-ray units
- 5.3. Gamma ray beams and gamma ray units
- 5.4. Particle accelerators
- 5.5. Linacs
- 5.6. Radiotherapy with protons, neutrons, and heavy ions
- 5.7. Shielding considerations
- 5.8. Cobalt-60 teletherapy units versus linacs
- 5.9. Simulators and computed tomography simulators
- 5.10. Training requirements



5.1 INTRODUCTION

- ❑ The study and use of ionizing radiation in medicine started with three important discoveries:
 - X rays by Wilhelm Roentgen in 1895.
 - Natural radioactivity by Henri Becquerel in 1896.
 - Radium-226 by Pierre and Marie Curie in 1898.



Radiation Oncology Physics: A Handbook for Teachers and Students - 5.1 Slide 1 (3/126)

5.1 INTRODUCTION

- ❑ Immediately upon the discovery of x rays and natural radioactivity, ionizing radiation has played an important role in:
 - Atomic and nuclear physics from the basic physics point of view.
 - In medicine providing an impetus for development of radiology and radiotherapy as medical specialties and medical physics as a specialty of physics.
 - In industry offering many non-destructive measurement techniques and special techniques used in evaluation of oil fields.
 - In agriculture providing food sterilization and pest control.



Radiation Oncology Physics: A Handbook for Teachers and Students - 5.1 Slide 2 (4/126)

5.1 INTRODUCTION

- ❑ During **the first 50 years** of radiation medicine the technological progress was aimed mainly towards:
 - Development of analog imaging techniques.
 - Optimization of image quality with concurrent minimization of dose.
 - Ever increasing energies and beam intensities.

- ❑ During **the past two decades** most developments in radiation medicine were related to:
 - Integration of computers in imaging
 - Development of digital imaging techniques
 - Incorporation of computers into therapeutic dose delivery with high energy linear accelerators (linacs).



Radiation Oncology Physics: A Handbook for Teachers and Students - 5.1 Slide 3 (5/126)

5.1 INTRODUCTION

- ❑ **Roentgen** discovered x rays in 1895 while experimenting with a Crookes “cold cathode” tube.
 - Crookes tube is a sealed glass cylinder with two embedded electrodes operated with rarefied gas.
 - The potential difference between the two electrodes produces discharge in the rarefied gas causing ionization of gas molecules.
 - Electrons (cathode rays) are accelerated toward the positive electrode producing x rays upon striking it.

Photograph of Roentgen's apparatus

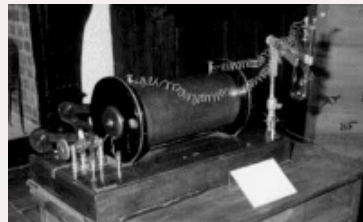

Radiation Oncology Physics: A Handbook for Teachers and Students - 5.1 Slide 4 (6/126)

5.1 INTRODUCTION

- ❑ Coolidge in 1913 designed a “hot cathode” x ray tube and his design is still in use today.
 - The main characteristics of the Coolidge tube are its high vacuum and its use of heated filament (cathode).
 - The heated filament emits electrons through thermionic emission.
 - X rays are produced in the target (anode) through radiation losses of electrons producing characteristic and bremsstrahlung photons.
 - The maximum photon energy produced in the target equals the kinetic energy of electrons striking the target.

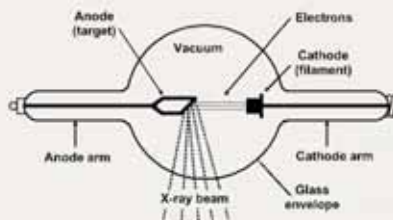

Radiation Oncology Physics: A Handbook for Teachers and Students - 5.1 Slide 5 (7/126)

5.1 INTRODUCTION

- ❑ The invention of the cobalt-60 teletherapy machine by Harold E. Johns in Canada in the early 1950s provided a tremendous boost in the quest for higher photon energies and placed the cobalt unit at the forefront of radiotherapy for a number of years.
 - Most modern cobalt therapy machines are arranged on a gantry so that the source may rotate about a horizontal axis referred to as the machine isocentre axis.
 - The source-axis distance (SAD) is either 80 cm or 100 cm.



Radiation Oncology Physics: A Handbook for Teachers and Students - 5.1 Slide 6 (8/126)

5.1 INTRODUCTION

❑ Cobalt-60 isocentric teletherapy machine

- Machine was built in the 1970s and 1980s by Atomic Energy of Canada, Ltd., Ottawa
- Source-axis distance = 80 cm



Radiation Oncology Physics: A Handbook for Teachers and Students - 5.1 Slide 7 (9/126)

5.1 INTRODUCTION

- ❑ At about the same time as cobalt machines **clinical linear accelerators (linacs)** were developed. They allowed even higher x-ray energies, eventually eclipsed the cobalt machines and became the most widely used radiation source in modern radiotherapy.
- ❑ With its compact and efficient design:
 - **Linac offers excellent versatility** for use in radiotherapy through isocentric mounting
 - **Provides either electron or x-ray therapy** with megavoltage beam energies.



Radiation Oncology Physics: A Handbook for Teachers and Students - 5.1 Slide 8 (10/126)

5.1 INTRODUCTION

Standard machines used for modern radiotherapy:

- X-ray machine:
 - Superficial x-ray machine: 50 - 80 kVp
 - Orthovoltage x-ray machine: 80 - 350 kVp
- Cobalt-60 teletherapy machine
- Linear accelerator (linac):
 - Megavoltage x rays: 6 - 25 MV
 - Electrons: 6 - 30 MeV



Radiation Oncology Physics: A Handbook for Teachers and Students - 5.1 Slide 9 (11/126)

5.1 INTRODUCTION

Specialized machines used for modern radiotherapy:

- Microtron: megavoltage x rays and electrons
- Betatron: megavoltage x rays and electrons
- Neutron machines
 - Neutron generator: (d,t) machine producing 14 MeV neutrons
 - Cyclotron accelerating protons
- Proton machines
 - Cyclotron
 - Synchrotron



Radiation Oncology Physics: A Handbook for Teachers and Students - 5.1 Slide 10 (12/126)

5.2 X-RAY BEAMS AND X-RAY UNITS

- ❑ **Clinical x-ray beams** typically range in energy between 10 kVp and 50 MV and are produced in x-ray targets when electrons with kinetic energies between 10 keV and 50 MeV strike special metallic targets.
- ❑ In the target most of the electron's kinetic energy is transformed into heat, and a small fraction of the kinetic energy is emitted in the form of x ray photons which are divided into two categories:
 - **Characteristic x rays**
following electron - orbital electron interactions
 - **Bremsstrahlung photons**
following electron - nucleus interactions



Radiation Oncology Physics: A Handbook for Teachers and Students - 5.2 Slide 1 (13/126)

5.2 X-RAY BEAMS AND X-RAY UNITS

5.2.1 Characteristic x rays

- ❑ **Characteristic X rays** result from Coulomb interactions between the incident electron and atomic orbital electrons of the target material (collision loss).
- ❑ The orbital electron is ejected from its shell and an electron from a higher level shell fills the resulting orbital vacancy.
- ❑ The energy difference between the two shells is:
 - Either emitted from the target atom in the form of a photon referred to as **characteristic photon**.
 - Or transferred to another orbital electron that is ejected from the target atom as an **Auger electron**.



Radiation Oncology Physics: A Handbook for Teachers and Students - 5.2.1 Slide 1 (14/126)

5.2 X-RAY BEAMS AND X-RAY UNITS

5.2.1 Characteristic x rays

- Characteristic photon $h\nu$ and Auger electron e_{KLM} following a vacancy in the atomic K shell.

Energy of K_α photon:

$$(h\nu)_{K_\alpha} = (E_B)_K - (E_B)_L$$

Energy of e_{KLM} Auger electron:

$$(E_K)_{e_{KLM}} = (E_B)_K - (E_B)_L - (E_B)_M$$

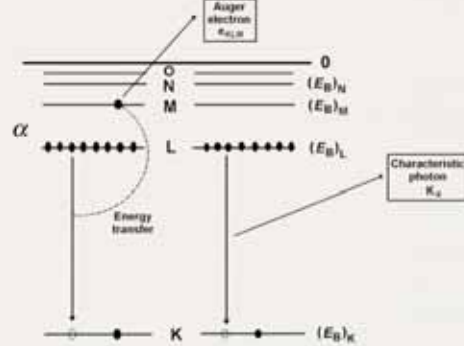

Radiation Oncology Physics: A Handbook for Teachers and Students - 5.2.1 Slide 2 (15/126)

5.2 X-RAY BEAMS AND X-RAY UNITS

5.2.1 Characteristic x rays

- Fluorescent yield ω gives the number of fluorescent (characteristic) photons emitted per vacancy in a shell.
- K-shell vacancies are the most prominent sources of characteristic x rays.
- Range of ω_K :

- $\omega_K = 0$ for small Z .
- $\omega_K = 0.5$ for $Z = 30$.
- $\omega_K = 0.96$ for high Z .

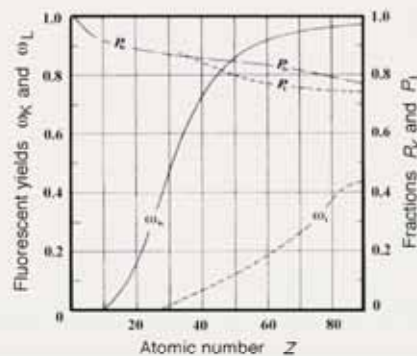

Radiation Oncology Physics: A Handbook for Teachers and Students - 5.2.1 Slide 3 (16/126)

5.2 X-RAY BEAMS AND X-RAY UNITS

5.2.2 Bremsstrahlung (continuous) x rays

- ❑ Bremsstrahlung x rays result from Coulomb interactions between the incident electron and the nuclei of the target material.
 - During the interaction the incident electron is accelerated and loses part of its kinetic energy in the form of bremsstrahlung photons.
 - The interaction is also referred to as radiation loss producing braking radiation.



Radiation Oncology Physics: A Handbook for Teachers and Students - 5.2.2 Slide 1 (17/126)

5.2 X-RAY BEAMS AND X-RAY UNITS

5.2.2 Bremsstrahlung (continuous) x rays

- ❑ In bremsstrahlung interaction x rays with energies ranging from zero to the kinetic energy of the incident electron may be produced, resulting in a continuous photon spectrum.
- ❑ The bremsstrahlung spectrum produced in a given x-ray target depends upon:
 - Kinetic energy of the incident electron
 - Atomic number of the target
 - Thickness of the target



Radiation Oncology Physics: A Handbook for Teachers and Students - 5.2.2 Slide 2 (18/126)

5.2 X-RAY BEAMS AND X-RAY UNITS

5.2.3 X-ray targets

- The **range R of a charged particle** in a particular absorbing medium is an experimental concept providing the thickness of the absorber that the particle can just penetrate.
- With regard to the range R of electrons with kinetic energy E_K in the target material of atomic number Z two types of targets are known:
 - **Thin targets** with thickness much smaller than R .
 - **Thick targets** with thickness of the order of R .



Radiation Oncology Physics: A Handbook for Teachers and Students - 5.2.3 Slide 1 (19/126)

5.2 X-RAY BEAMS AND X-RAY UNITS

5.2.3 X-ray targets

- For **thin target radiation** and electron kinetic energy E_K :
 - Intensity of emitted radiation is proportional to the number of photons N times their energy E_K .
 - Intensity of radiation emitted into each photon energy interval between 0 and E_K is constant.
 - The total energy emitted in the form of radiation from a thin target is proportional to $(Z^* E_K)$.

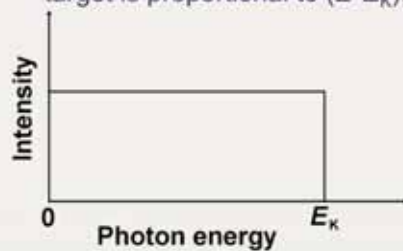

Radiation Oncology Physics: A Handbook for Teachers and Students - 5.2.3 Slide 2 (20/126)

5.2 X-RAY BEAMS AND X-RAY UNITS

5.2.3 X-ray targets

- ❑ **Thick target radiation** may be considered as a superposition of a large number of thin target radiations.
- ❑ The intensity $I(h\nu)$ of the thick target radiation spectrum is expressed as $I(h\nu) = CZ(E_k - h\nu)$.
- ❑ In practice thickness of thick x-ray targets is about $1.1 R$ to satisfy two opposing conditions:
 - To ensure that no electrons that strike the target can traverse the target.
 - To minimize the attenuation of the bremsstrahlung beam in the target.



Radiation Oncology Physics: A Handbook for Teachers and Students - 5.2.3 Slide 3 (21/126)

5.2 X-RAY BEAMS AND X-RAY UNITS

5.2.3 X-ray targets

- ❑ Figure shows, for 100 keV electrons striking a target:
 - Plot (1): **thin target spectrum**.
 - Plots (2), (3), and (4): thick target spectrum as a superposition of a series of thin target spectra:

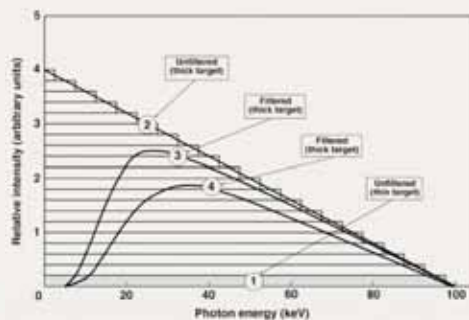

- (2) Unfiltered beam inside the x-ray tube.
- (3) Beam filtered only with tube window.
- (4) Beam filtered with tube window and additional filtration.



Radiation Oncology Physics: A Handbook for Teachers and Students - 5.2.3 Slide 4 (22/126)

5.2 X-RAY BEAMS AND X-RAY UNITS

5.2.4 Clinical x-ray beams

□ A typical spectrum of a clinical x-ray beam consists of:

- Continuous bremsstrahlung spectrum
- Line spectra characteristic of the target material and superimposed onto the continuous bremsstrahlung spectrum.

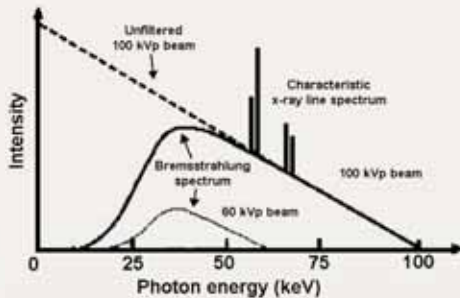

The bremsstrahlung spectrum originates in the x-ray target.

The characteristic line spectra originate in the target and in any attenuators placed into the x-ray beam.



Radiation Oncology Physics: A Handbook for Teachers and Students - 5.2.4 Slide 1 (23/126)

5.2 X-RAY BEAMS AND X-RAY UNITS

5.2.4 Clinical x-ray beams

□ The relative proportion of the number of the characteristic photons to bremsstrahlung photons in an x-ray beam spectrum varies with:

- Kinetic energy of the electron beam striking the x-ray target.
- Atomic number of the target.

□ For example, x-ray beams produced in a tungsten target by 100 keV electrons contain about:

- 20% in characteristic photons.
- 80% in bremsstrahlung photons.

□ In the megavoltage range the contribution of characteristic photons to the total spectrum is negligible.



Radiation Oncology Physics: A Handbook for Teachers and Students - 5.2.4 Slide 2 (24/126)

5.2 X-RAY BEAMS AND X-RAY UNITS

5.2.4 Clinical x-ray beams

- ❑ In the **diagnostic energy range** (10 kVp - 150 kVp) most photons are produced at close to 90° from the direction of electrons striking the target (x-ray tube).
- ❑ In the **megavoltage energy range** (1 MV - 50 MV) most photons are produced in the direction of the electron beam striking the target (linac).

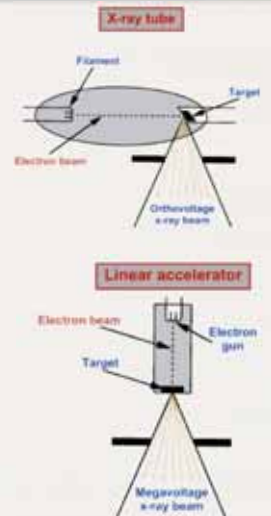

Radiation Oncology Physics: A Handbook for Teachers and Students - 5.2.4 Slide 3 (25/126)

5.2 X-RAY BEAMS AND X-RAY UNITS

5.2.5 X-ray beam quality specifiers

- ❑ The term **“beam quality”** is used to indicate the ability of a beam to penetrate a water phantom.
 - The x-ray beam’s penetrative ability is a function of the beam’s spectrum.
 - Various parameters are used as **beam quality specifier**, however, it is not possible to use a given specifier in the whole energy range of interest in clinical physics (from superficial x rays to high-energy megavoltage x rays).



Radiation Oncology Physics: A Handbook for Teachers and Students - 5.2.5 Slide 1 (26/126)

5.2 X-RAY BEAMS AND X-RAY UNITS

5.2.5 X-ray beam quality specifiers

□ Known x-ray beam quality specifiers or indices:

- Complete x-ray spectrum
- Half-value layer (HVL)
- Effective energy for a heterogeneous x-ray beam
- Nominal accelerating potential (NAP)
- Tissue-phantom ratio (TPR)
- Percentage depth dose (PDD)



Radiation Oncology Physics: A Handbook for Teachers and Students - 5.2.5 Slide 2 (27/126)

5.2 X-RAY BEAMS AND X-RAY UNITS

5.2.5 X-ray beam quality specifiers

□ Complete x-ray spectrum:

- Gives the most rigorous description of beam quality.
- Is important for quality assurance (QA) and quality control (QC) of clinical radiographic systems.
- Is difficult to measure directly under clinical conditions because of the high photon fluence rate that can cause significant photon pile up in the detector.



Radiation Oncology Physics: A Handbook for Teachers and Students - 5.2.5 Slide 3 (28/126)

5.2 X-RAY BEAMS AND X-RAY UNITS

5.2.5 X-ray beam quality specifiers

☐ Measurement of complete x-ray spectrum:

- Direct measurement with CdTe detector and multi-channel analyzer.
- Measurement with diffraction spectrometer using the concept of Bragg reflection on a single crystal. The intensity of the x rays is registered as a function of the wavelength.
- Measurement with high resolution detector using 90° Compton scattering from a given sample. From the measured scatter spectrum energy correction and Klein-Nishina function are used to reconstruct the actual spectrum.



Radiation Oncology Physics: A Handbook for Teachers and Students - 5.2.5 Slide 4 (29/126)

5.2 X-RAY BEAMS AND X-RAY UNITS

5.2.5 X-ray beam quality specifiers

☐ Half-value layer (HVL):

- HVL is practical for beam quality description in the diagnostic x-ray energy region (superficial and orthovoltage) in which the attenuation coefficient depends strongly on photon energy.
- HVL is not used in the megavoltage energy region because in this region the attenuation coefficient is only a slowly varying function of photon energy.
- In the superficial energy region HVL is usually given in mm of aluminum.
- In the orthovoltage energy region HVL is usually given in mm of copper.



Radiation Oncology Physics: A Handbook for Teachers and Students - 5.2.5 Slide 5 (30/126)

5.2 X-RAY BEAMS AND X-RAY UNITS

5.2.5 X-ray beam quality specifiers

□ Measurement of half-value layer (HVL):

To minimize the effects of radiation scattered in the attenuator the HVL should be measured under “good geometry” conditions that imply the use of:

- **Narrow beam geometry** to minimize the scattering from the attenuator.
- **Reasonable distance between the attenuator and the detector** to minimize the number of scattered photons reaching the detector.
- **An ionization chamber with air equivalent walls and flat photon energy response in the beam spectrum.**



Radiation Oncology Physics: A Handbook for Teachers and Students - 5.2.5 Slide 6 (31/126)

5.2 X-RAY BEAMS AND X-RAY UNITS

5.2.5 X-ray beam quality specifiers

- #### □ Effective energy of a heterogeneous x-ray beam is defined as that energy of a monoenergetic photon beam that yields the same HVL as does the heterogeneous beam.

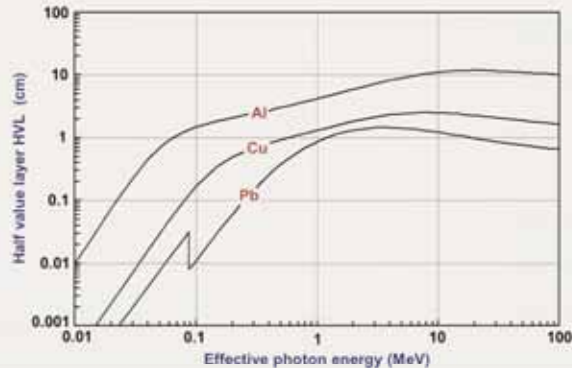

Radiation Oncology Physics: A Handbook for Teachers and Students - 5.2.5 Slide 7 (32/126)

5.2 X-RAY BEAMS AND X-RAY UNITS

5.2.5 X-ray beam quality specifiers

□ Nominal accelerating potential (NAP)

- NAP was introduced in the AAPM TG 21 dosimetry protocol (1983) as a matter of convenience and is related to the energy of the electrons striking the target.
- NAP is defined in terms of the ionization ratio measured in water on central beam axis at a fixed SAD of 100 cm and a field size of 10x10 cm² for depths z of 20 cm and 10 cm.

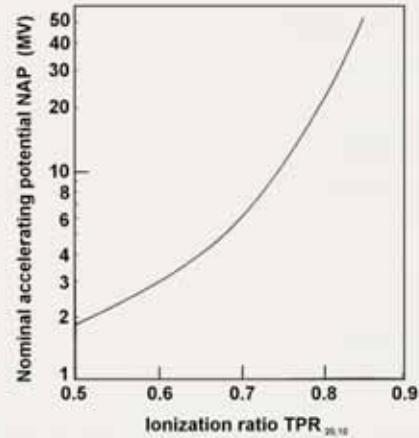

Radiation Oncology Physics: A Handbook for Teachers and Students - 5.2.5 Slide 8 (33/126)

5.2 X-RAY BEAMS AND X-RAY UNITS

5.2.5 X-ray beam quality specifiers

□ Tissue-phantom ratio TPR_{20,10}:

- TPR_{20,10} is defined as the ratio of doses on the beam central axis at depths of z = 20 cm and z = 10 cm in water obtained at an SAD of 100 cm and a field size of 10x10 cm².
- TPR_{20,10} is independent of electron contamination of the incident photon beam.
- TPR_{20,10} is used as megavoltage beam quality specifier in the IAEA-TRS 398 dosimetry protocol.
- TPR_{20,10} is related to measured PDD_{20,10} as

$$\text{TPR}_{20,10} = 1.2661 \text{PDD}_{20,10} - 0.0595$$



Radiation Oncology Physics: A Handbook for Teachers and Students - 5.2.5 Slide 9 (34/126)

5.2 X-RAY BEAMS AND X-RAY UNITS

5.2.5 X-ray beam quality specifiers

□ Percentage depth dose PDD(10):

- PDD(10) is defined as the percentage depth dose measure in water on the beam central axis for a 10x10 cm² field and an SSD of 100 cm.
- The problem of electron beam contamination of the megavoltage photon beam is circumvented by placing a 1 mm thick lead foil into the beam to remove the unknown electron contamination.
- The electron contamination contributed by the lead foil can be assumed known and is determined with Monte Carlo calculations.
- $PDD(10)_x$ for the pure photon beam can be calculated from $PDD(10)_{Pb}$ using a correction formula.



Radiation Oncology Physics: A Handbook for Teachers and Students - 5.2.5 Slide 10 (35/126)

5.2 X-RAY BEAMS AND X-RAY UNITS

5.2.6 X-ray machines for radiotherapy

□ Superficial and orthovoltage beams used in radiotherapy are produced by x-ray machines. The main components of a radiotherapy x-ray machine are:

- X-ray tube
- Ceiling or floor mount for the x-ray tube
- Target cooling system
- Control console
- X-ray power generator

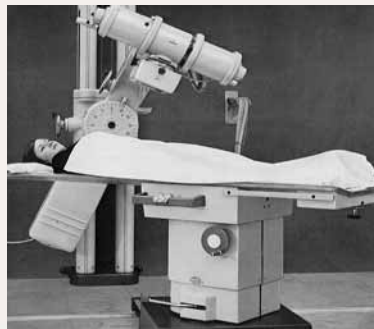

Radiation Oncology Physics: A Handbook for Teachers and Students - 5.2.6 Slide 1 (36/126)

5.2 X-RAY BEAMS AND X-RAY UNITS

5.2.6 X-ray machines for radiotherapy

- The components of a radiotherapy x-ray machine:

- X-ray tube
- Applicators

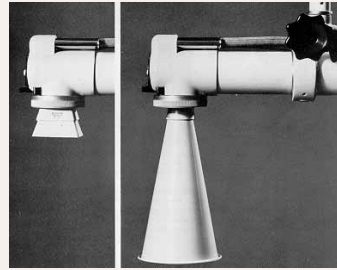

Radiation Oncology Physics: A Handbook for Teachers and Students - 5.2.6 Slide 2 (37/126)

5.2 X-RAY BEAMS AND X-RAY UNITS

5.2.6 X-ray machines for radiotherapy

- The main components of a typical therapy x-ray tube are:

- Water or oil cooled target (anode)
- Heated filament (cathode)

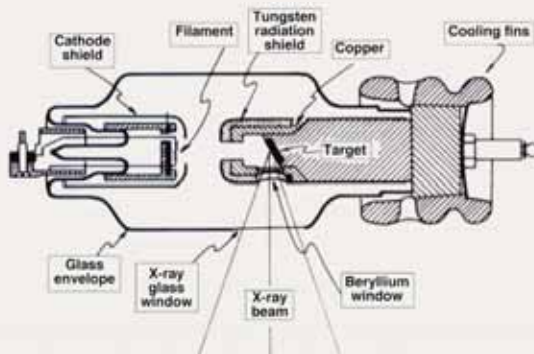

Based on Fig. 2.8,
Johns and Cunningham,
Physics of Radiology,
C.C. Thomas,
Springfield, Illinois, 1984
(reproduced with permission)



Radiation Oncology Physics: A Handbook for Teachers and Students - 5.2.6 Slide 3 (38/126)

5.2 X-RAY BEAMS AND X-RAY UNITS

5.2.6 X-ray machines for radiotherapy

- ❑ With x-ray tubes the patient dose is delivered using a **timer** and the treatment time must incorporate a **shutter correction time**.
- ❑ In comparison with diagnostic radiology x-ray tubes, a **therapy x-ray tube** operates:
 - At about 10% of instantaneous current.
 - At about 10 times average energy input.
 - With a significantly larger focal spot.
 - With a fixed rather than rotating anode.



Radiation Oncology Physics: A Handbook for Teachers and Students - 5.2.6 Slide 4 (39/126)

5.3 GAMMA RAY BEAMS AND GAMMA RAY UNITS

5.3.1 Basic properties of gamma rays

- ❑ For use in external beam radiotherapy, **gamma rays** are obtained from specially designed and built sources that contain a suitable, artificially produced radionuclide.
- ❑ The parent source material undergoes beta minus decay resulting in excited daughter nuclei that attain ground state through emission of gamma rays (gamma decay).



Radiation Oncology Physics: A Handbook for Teachers and Students - 5.3.1 Slide 1 (40/126)

5.3 GAMMA RAY BEAMS AND GAMMA RAY UNITS

5.3.1 Basic properties of gamma rays

- The important characteristics of radionuclides useful for external beam radiotherapy are:
 - High gamma ray energy (of the order of 1 MeV).
 - High specific activity (of the order of 100 Ci/g).
 - Relatively long half life (of the order of several years).
 - Large specific air kerma rate constant.
- Of over 3000 radionuclides known only 3 meet the required characteristics and essentially only cobalt-60 is currently used for external beam radiotherapy.



Radiation Oncology Physics: A Handbook for Teachers and Students - 5.3.1 Slide 2 (41/126)

5.3 GAMMA RAY BEAMS AND GAMMA RAY UNITS

5.3.1 Basic properties of gamma rays

- Specific activity a is defined as the activity A per mass m of a radionuclide) is linearly proportional to the decay constant λ and inversely proportional to the half-life $t_{1/2}$

$$a = \frac{A}{m} = \frac{\lambda N}{m} = \frac{\ln 2}{t_{1/2}} \frac{N_A}{A}$$

- Specific activity
 - Radium-226: $a = 0.988$ Ci/g (original definition: 1 Ci/g)
 - Cobalt-60: $a = 1130$ Ci/g (carrier free); 300 Ci/g (in practice)
 - Cesium-137: $a = 80$ Ci/g



Radiation Oncology Physics: A Handbook for Teachers and Students - 5.3.1 Slide 3 (42/126)

5.3 GAMMA RAY BEAMS AND GAMMA RAY UNITS

5.3.1 Basic properties of gamma rays

- Air kerma rate in air $(\dot{K}_{\text{air}})_{\text{air}}$ is proportional to the specific air kerma rate constant Γ_{AKR} and inversely proportional to d^2 , the distance between the source and the point of interest

$$(\dot{K}_{\text{air}})_{\text{air}} = \frac{A \Gamma_{\text{AKR}}}{d^2}$$

- Specific air kerma rate constant Γ_{AKR} in [$\mu\text{Gy} \cdot \text{m}^2 / (\text{GBq} \cdot \text{h})$]
 - Cobalt-60: $\Gamma_{\text{AKR}} = 309 \mu\text{Gy} \cdot \text{m}^2 / (\text{GBq} \cdot \text{h})$
 - Cesium-137: $\Gamma_{\text{AKR}} = 78 \mu\text{Gy} \cdot \text{m}^2 / (\text{GBq} \cdot \text{h})$



Radiation Oncology Physics: A Handbook for Teachers and Students - 5.3.1 Slide 4 (43/126)

5.3 GAMMA RAY BEAMS AND GAMMA RAY UNITS

5.3.2 Teletherapy machines

- Treatment machines used for external beam radiotherapy with gamma ray sources are called **teletherapy machines**. They are most often mounted isocentrically with SAD of 80 cm or 100 cm.
- The **main components of a teletherapy machine** are:
 - Radioactive source
 - Source housing, including beam collimator and source movement mechanism.
 - Gantry and stand.
 - Patient support assembly.
 - Machine control console.



Radiation Oncology Physics: A Handbook for Teachers and Students - 5.3.2 Slide 1 (44/126)

5.3 GAMMA RAY BEAMS AND GAMMA RAY UNITS

5.3.2 Teletherapy machines

Cobalt-60 teletherapy machine, Theratron-780, AECL (now MDS Nordion), Ottawa, Canada



Radiation Oncology Physics: A Handbook for Teachers and Students - 5.3.2 Slide 2 (45/126)

5.3 GAMMA RAY BEAMS AND GAMMA RAY UNITS

5.3.2 Teletherapy machines



□ Schematic diagram of a cobalt-60 teletherapy machine:

- Depicted on a postage stamp issued by Canada Post in 1988
- In honor of Harold E. Johns, who invented the cobalt-60 machine in the 1950s.
- *Reprinted with permission from Canada Post.*



Radiation Oncology Physics: A Handbook for Teachers and Students - 5.3.2 Slide 3 (46/126)

5.3 GAMMA RAY BEAMS AND GAMMA RAY UNITS

5.3.3 Teletherapy sources

- ❑ To facilitate interchange of sources from one teletherapy machine to another and from one radionuclide production facility to another, **standard source capsules** have been developed.
- ❑ Teletherapy sources are cylinders with height of 2.5 cm and diameter of 1, 1.5, or 2 cm.
 - The smaller is the source diameter, the smaller is the physical beam penumbra and the more expensive is the source.
 - Often a diameter of 1.5 cm is chosen as a compromise between the cost and penumbra.



Radiation Oncology Physics: A Handbook for Teachers and Students - 5.3.3 Slide 1 (47/126)

5.3 GAMMA RAY BEAMS AND GAMMA RAY UNITS

5.3.3 Teletherapy sources

- ❑ Typical **source activity**: of the order of 5 000 - 10 000 Ci (185 - 370 TBq).
- ❑ Typical **dose rates at 80 cm** from source: of the order of 100 - 200 cGy/min
- ❑ Teletherapy source is usually replaced within one half-life after it is installed. Financial considerations often result in longer source usage.



Radiation Oncology Physics: A Handbook for Teachers and Students - 5.3.3 Slide 2 (48/126)

5.3 GAMMA RAY BEAMS AND GAMMA RAY UNITS

5.3.3 Teletherapy sources

- Teletherapy radionuclides: cobalt-60 and cesium-137
 - Both decay through beta minus decay
 - Half-life of cobalt-60 is 5.26 y; of cesium-137 is 30 y
 - The beta particles (electrons) are absorbed in the source capsule.

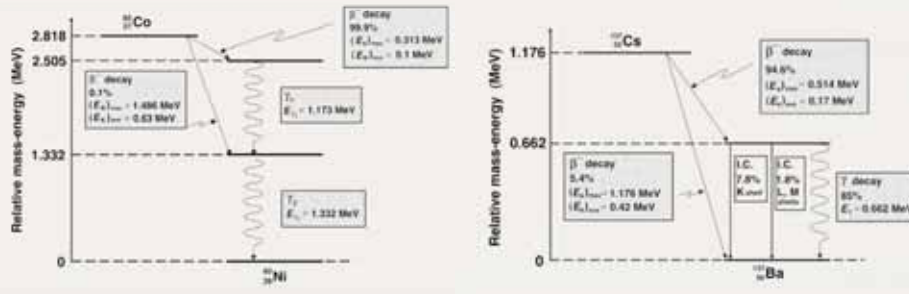

Radiation Oncology Physics: A Handbook for Teachers and Students - 5.3.3 Slide 3 (49/126)

5.3 GAMMA RAY BEAMS AND GAMMA RAY UNITS

5.3.4 Teletherapy source housing

- The **source head** consists of:
 - Steel shell with lead for shielding purposes
 - Mechanism for bringing the source in front of the collimator opening to produce the clinical gamma ray beam.
- Currently, two methods are used for moving the teletherapy source from the **BEAM-OFF** into the **BEAM-ON** position and back:
 - Source on a **sliding drawer**
 - Source on a **rotating cylinder**



Radiation Oncology Physics: A Handbook for Teachers and Students - 5.3.4 Slide 1 (50/126)

5.3 GAMMA RAY BEAMS AND GAMMA RAY UNITS

5.3.4 Teletherapy source housing

- Methods for moving the teletherapy source from the **BEAM-OFF** into the **BEAM-ON** position and back:
Source on a **sliding drawer** Source on a **rotating cylinder**

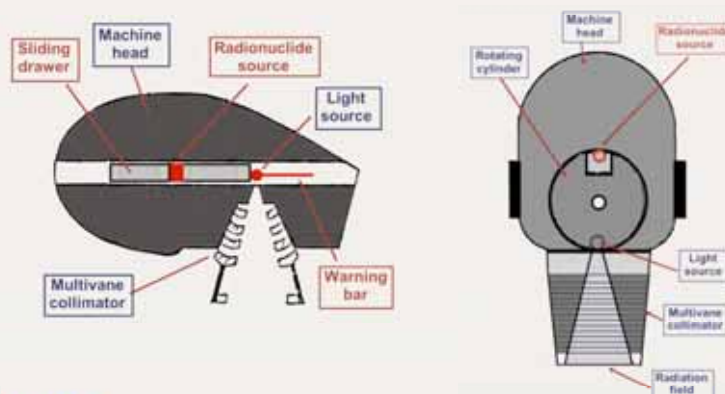

Radiation Oncology Physics: A Handbook for Teachers and Students - 5.3.4 Slide 2 (51/126)

5.3 GAMMA RAY BEAMS AND GAMMA RAY UNITS

5.3.4 Teletherapy source housing

- Both methods (**source-on-drawer** and **source-on-cylinder**) incorporate a safety feature in which the beam is terminated automatically in the event of power failure or emergency.
- When the source is in the **BEAM-OFF** position, a **light source** appears in the **BEAM-ON** position above the collimator opening, allowing an optical visualization of the radiation field, as defined by the machine collimator.



Radiation Oncology Physics: A Handbook for Teachers and Students - 5.3.4 Slide 3 (52/126)

5.3 GAMMA RAY BEAMS AND GAMMA RAY UNITS

5.3.4 Teletherapy source housing

- Some radiation (**leakage radiation**) will escape from the teletherapy machine even when the source is in the BEAM-OFF position.
 - **Head leakage** typically amounts to less than 1 mR/h (0.01 mSv/h) at 1 m from the source.
 - International regulations require that **average leakage** of a teletherapy machine head be less than 2 mR/h (0.02 mSv/h).



Radiation Oncology Physics: A Handbook for Teachers and Students - 5.3.4 Slide 4 (53/126)

5.3 GAMMA RAY BEAMS AND GAMMA RAY UNITS

5.3.5 Dose delivery with teletherapy machines

- The prescribed dose is delivered to the patient with the help of two **treatment timers: primary and secondary**.
 - The **primary timer** actually controls the treatment time and turns the beam off upon reaching the prescribed beam-on time.
 - The **secondary timer** serves as a backup timer in case of the primary timer's failure to turn the beam off.
- The set treatment time should incorporate the **shutter correction time** to account for the travel time of the source from the BEAM-OFF to the BEAM-ON position at the start of the irradiation and for the reverse travel at the end of irradiation.



Radiation Oncology Physics: A Handbook for Teachers and Students - 5.3.5 Slide 1 (54/126)

5.3 GAMMA RAY BEAMS AND GAMMA RAY UNITS

5.3.6 Collimator and penumbra

- ❑ **Collimators** of teletherapy machines provide square and rectangular radiation fields typically ranging from 5x5 to 35x35 cm² at 80 cm from the source.
- ❑ The **geometric penumbra** resulting from the finite source diameter, may be minimized by using:
 - Small source diameter
 - Penumbra trimmers as close as possible to the patient's skin ($z = 0$)

$$\frac{P(z)}{s} = \frac{(SSD + z - SDD)}{SDD}$$

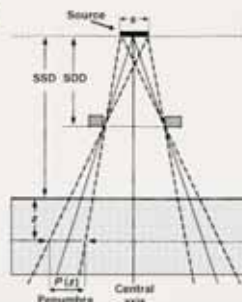

Radiation Oncology Physics: A Handbook for Teachers and Students - 5.3.6 Slide 1 (55/126)

5.4 PARTICLE ACCELERATORS

- ❑ Many types of accelerator have been built for basic research in nuclear physics and high energy physics.
- ❑ Most of these accelerators have been modified for at least some limited use in radiotherapy.
- ❑ Irrespective of accelerator type, **two basic conditions must be met for particle acceleration**:
 - The particle to be accelerated must be charged
 - Electric field must be provided in the direction of particle acceleration



Radiation Oncology Physics: A Handbook for Teachers and Students - 5.4 Slide 1 (56/126)

5.4 PARTICLE ACCELERATORS

- ❑ As far as the accelerating electric field is concerned there are **two main classes of accelerator: electrostatic and cyclic.**
 - In **electrostatic accelerators** the particles are accelerated by applying an electrostatic electric field through a voltage difference, constant in time, whose value fixes the value of the final kinetic energy of the particle.
 - In **cyclic accelerators** the electric fields used for particle acceleration are variable and associated with a variable magnetic field. This results in some closed paths along which the kinetic energy gained by the particle differs from zero.



Radiation Oncology Physics: A Handbook for Teachers and Students - 5.4 Slide 2 (57/126)

5.4 PARTICLE ACCELERATORS

- ❑ **Electrostatic accelerators used in medicine:**
 - **Superficial and orthovoltage x-ray machines**
 - Neutron generators for cancer therapy
- ❑ **Cyclic accelerators used in medicine**
 - **Linear accelerator (linac)**
 - Microtron
 - Betatron
 - Cyclotron
 - Synchrotron



Radiation Oncology Physics: A Handbook for Teachers and Students - 5.4 Slide 3 (58/126)

5.4 PARTICLE ACCELERATORS

5.4.1 Betatron

- ❑ **Betatron** is a **cyclic accelerator** in which the electrons are made to circulate in a toroidal vacuum chamber (doughnut) that is placed into a gap between two magnet poles.
- ❑ Conceptually, the betatron may be considered an analog of a transformer:
 - Primary current is the alternating current exciting the magnet.
 - Secondary current is electron current circulating in the doughnut.

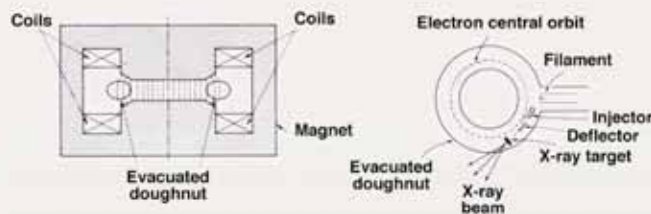

Radiation Oncology Physics: A Handbook for Teachers and Students - 5.4.1 Slide 1 (59/126)

5.4 PARTICLE ACCELERATORS

5.4.2 Cyclotron

- ❑ In a **cyclotron** the particles are accelerated along a spiral trajectory guided inside two evacuated half-cylindrical electrodes (dees) by a uniform magnetic field produced between the pole pieces of a large magnet (1 Tesla).

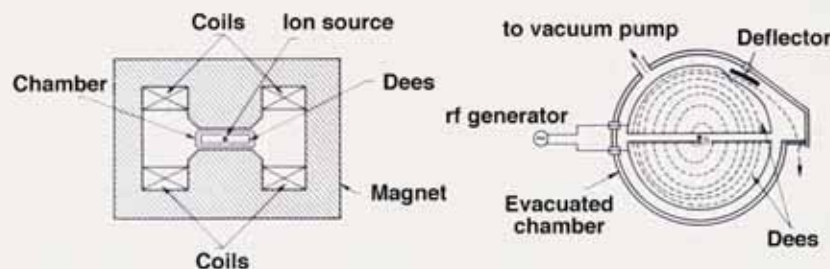

Radiation Oncology Physics: A Handbook for Teachers and Students - 5.4.2 Slide 1 (60/126)

5.4 PARTICLE ACCELERATORS

5.4.3 Microtron

- ❑ **Microtron** is an electron accelerator that combines the features of a linac and a cyclotron.
- ❑ The electron gains energy from a resonant wave guide cavity and describes circular orbits of increasing radius in a uniform magnetic field.
- ❑ After each passage through the wave guide the electrons gain an energy increment resulting in a larger radius for the next pass through the wave guide cavity.

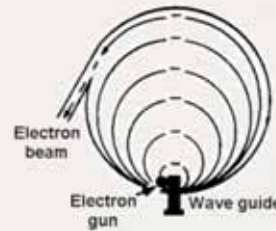

Radiation Oncology Physics: A Handbook for Teachers and Students - 5.4.3 Slide 1 (61/126)

5.5 LINACS

- ❑ **Medical linacs** are cyclic accelerators that accelerate electrons to kinetic energies from 4 to 25 MeV using microwave radiofrequency fields:
 - 10^3 MHz : L band
 - 2856 MHz: S band
 - 10^4 MHz: X band
- ❑ In a linac the electrons are accelerated following straight trajectories in special evacuated structures called **accelerating waveguides**.



Radiation Oncology Physics: A Handbook for Teachers and Students - 5.5 Slide 1 (62/126)

5.5 LINACS

5.5.1 Linac generations

- During the past 40 years, medical linacs have gone through five distinct generations, each one increasingly more sophisticated:
 - (1) Low energy x rays (4-6 MV).
 - (2) Medium energy x rays (10-15 MV) and electrons.
 - (3) High energy x rays (18-25 MV) and electrons.
 - (4) Computer controlled dual energy linac with electrons.
 - (5) Computer controlled dual energy linac with electrons combined with intensity modulation.



Radiation Oncology Physics: A Handbook for Teachers and Students - 5.5.1 Slide 1 (63/126)

5.5 LINACS

5.5.2 Safety of linac installations

- Safety of operation for the patient, operator, and the general public is of great concern because of the complexity of modern linacs.
- Three areas of safety are of interest
 - Mechanical
 - Electrical
 - Radiation
- Many national and international bodies are involved with issues related to linac safety.



Radiation Oncology Physics: A Handbook for Teachers and Students - 5.5.2 Slide 1 (64/126)

5.5 LINACS

5.5.3 Components of modern linacs

- Linacs are usually mounted isocentrically and their operational systems are distributed over five major and distinct sections of the machine:
 - Gantry
 - Gantry stand and support
 - Modulator cabinet
 - Patient support assembly
 - Control console



Radiation Oncology Physics: A Handbook for Teachers and Students - 5.5.3 Slide 1 (65/126)

5.5 LINACS

5.5.3 Components of modern linacs

- The main **beam forming components** of a modern medical linac are usually grouped into six classes:
 - (1) Injection system
 - (2) Radiofrequency power generation system
 - (3) Accelerating waveguide
 - (4) Auxiliary system
 - (5) Beam transport system
 - (6) Beam collimation and monitoring system



Radiation Oncology Physics: A Handbook for Teachers and Students - 5.5.3 Slide 2 (66/126)

5.5 LINACS

5.5.3 Components of modern linacs

- Schematic diagram of a modern fifth generation linac

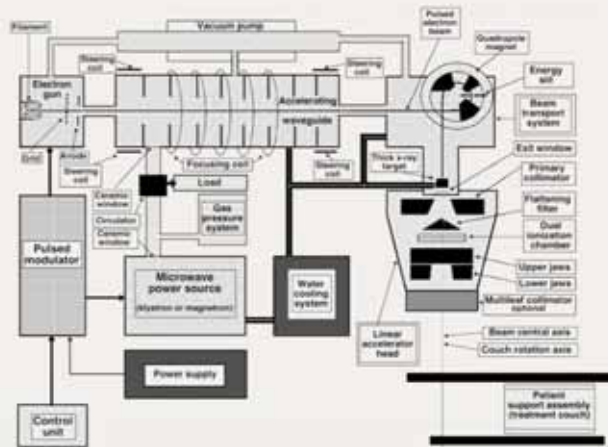

Radiation Oncology Physics: A Handbook for Teachers and Students - 5.5.3 Slide 3 (67/126)

5.5 LINACS

5.5.4 Configuration of modern linacs

- In the simplest and most practical linac configuration:
 - Electron source and the x-ray target form part of the accelerating waveguide
 - The electron source and the x-ray target are aligned directly with the linac isocentre obviating the need for a beam transport system.
 - Since the target is embedded into the waveguide, this linac type cannot produce clinical electron beams.

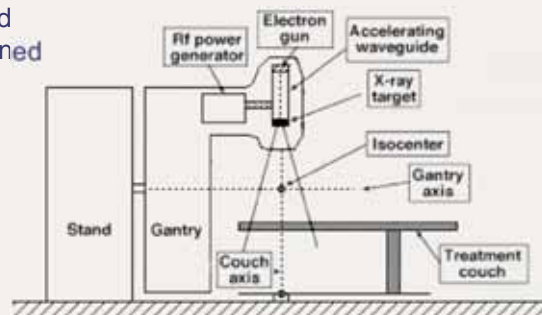

Radiation Oncology Physics: A Handbook for Teachers and Students - 5.5.4 Slide 1 (68/126)

5.5 LINACS

5.5.4 Configuration of modern linacs

- Accelerating waveguides for intermediate (8-15 MV) and high (15-30 MV) energy linacs are located:
 - Either in the gantry parallel to the gantry axis of rotation.
 - Or in the gantry stand.
 - In both cases, a **beam transport system** is used to transport the electron beam from the accelerating waveguide to the x-ray target.
 - The radiofrequency power source in both configurations is mounted in the gantry stand.



Radiation Oncology Physics: A Handbook for Teachers and Students - 5.5.4 Slide 2 (69/126)

5.5 LINACS

5.5.4 Linac generations

- Configurations for intermediate and high energy linacs

Waveguide in the gantry,
RF power source in gantry stand

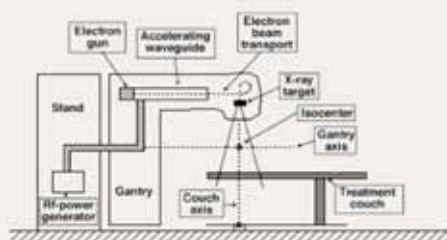

Waveguide in the gantry stand,
RF power source in gantry stand

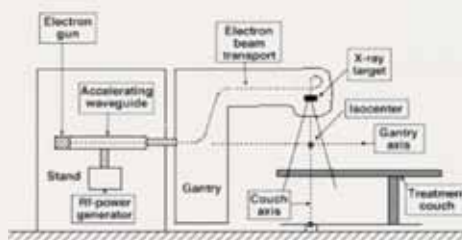

Radiation Oncology Physics: A Handbook for Teachers and Students - 5.5.4 Slide 3 (70/126)

5.5 LINACS

5.5.4 Linac generations

- Typical modern dual energy linac, incorporating imaging system and electronic portal imaging device (EPID), Elekta, Stockholm



Radiation Oncology Physics: A Handbook for Teachers and Students - 5.5.4 Slide 4 (71/126)

5.5 LINACS

5.5.4 Linac generations

- Typical modern dual energy linac, with on board imaging system and an electronic portal imaging device (EPID), Varian, Palo Alto, CA

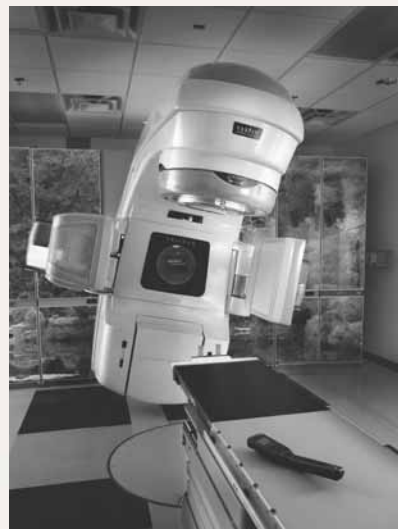

Radiation Oncology Physics: A Handbook for Teachers and Students - 5.5.4 Slide 5 (72/126)

5.5 LINACS

5.5.5 Injection system

- ❑ The **linac injection system** is the source of electrons, a simple electrostatic accelerator referred to as the **electron gun**.
- ❑ Two types of electron gun are in use in medical linacs:
 - Diode type
 - Triode type
- ❑ Both electron gun types contain:
 - Heated filament cathode
 - Perforated grounded anode
 - Triode gun also incorporates a grid



Radiation Oncology Physics: A Handbook for Teachers and Students - 5.5.5 Slide 1 (73/126)

5.5 LINACS

5.5.5 Injection system

- ❑ Two types of electron gun producing electrons in linac:

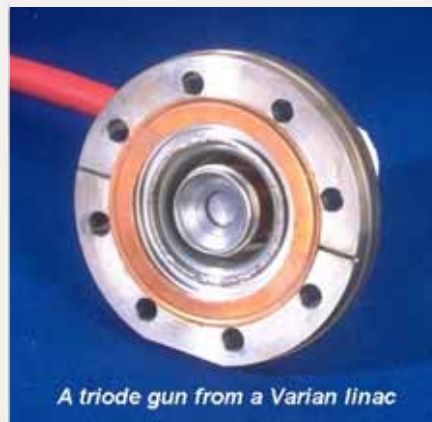
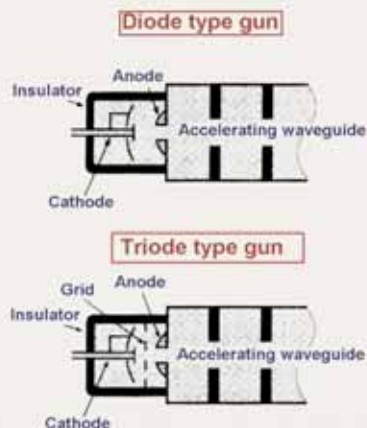

Radiation Oncology Physics: A Handbook for Teachers and Students - 5.5.5 Slide 2 (74/126)

5.5 LINACS

5.5.6 Radiofrequency power generation system

- The radiofrequency power generation system produces the microwave radiation used in the accelerating waveguide to accelerate electrons to the desired kinetic energy and consists of two major components:

- RF power source (magnetron or klystron)
- Pulsed modulator

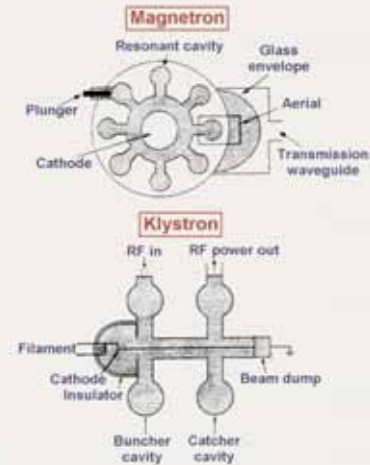

Radiation Oncology Physics: A Handbook for Teachers and Students - 5.5.6 Slide 1 (75/126)

5.5 LINACS

5.5.6 Radiofrequency power generation system

- Pulsed modulator produces the high voltage (~ 100 kV), high current (~ 100 A), short duration ($\sim 1 \mu\text{s}$) pulses required by the RF power source and the injection system.

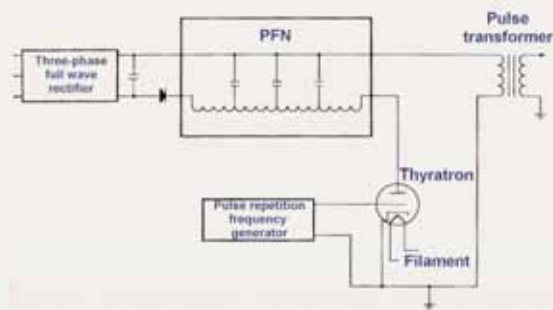

Radiation Oncology Physics: A Handbook for Teachers and Students - 5.5.6 Slide 2 (76/126)

5.5 LINACS

5.5.7 Accelerating waveguide

- ❑ Waveguides are evacuated or gas filled metallic structures of rectangular or circular cross-section used in transmission of microwaves.
- ❑ Two types of waveguide are used in linacs:
 - Radiofrequency power transmission waveguides (gas filled) for transmission of the RF power from the power source to the accelerating waveguide.
 - Accelerating waveguides (evacuated to about 10^{-6} tor) for acceleration of electrons.



Radiation Oncology Physics: A Handbook for Teachers and Students - 5.5.7 Slide 1 (77/126)

5.5 LINACS

5.5.7 Accelerating waveguide

- ❑ Accelerating waveguide is obtained from a cylindrical uniform waveguide by adding a series of disks (irises) with circular holes at the centre, placed at equal distances along the tube to form a series of cavities.
- ❑ The accelerating waveguide is evacuated to allow free propagation of electrons.
- ❑ The cavities serve two purposes:
 - To couple and distribute microwave power between cavities.
 - To provide a suitable electric field pattern for electron acceleration.

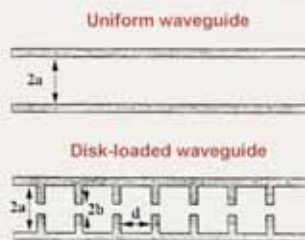

Radiation Oncology Physics: A Handbook for Teachers and Students - 5.5.7 Slide 2 (78/126)

5.5 LINACS

5.5.7 Accelerating waveguide

- ❑ The role of the **disks (irises)** is to slow down the phase velocity of the RF wave to a velocity below the speed of light in vacuum to allow acceleration of electrons.
- ❑ The accelerating waveguide is evacuated (10^{-6} tor) to allow free propagation of electrons.
- ❑ The cavities serve two purposes:
 - To couple and distribute microwave power between adjacent cavities.
 - To provide a suitable electric field pattern for electron acceleration.



Radiation Oncology Physics: A Handbook for Teachers and Students - 5.5.7 Slide 3 (79/126)

5.5 LINACS

5.5.7 Accelerating waveguide

- ❑ Two types of accelerating waveguide are in use:
 - Traveling wave structure
 - Standing wave structure

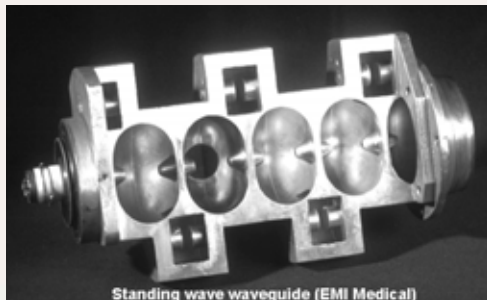

Standing wave waveguide (EMI Medical)

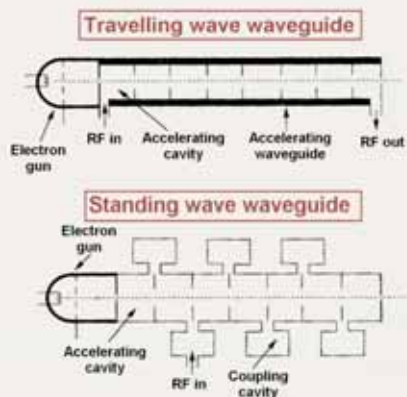

Radiation Oncology Physics: A Handbook for Teachers and Students - 5.5.7 Slide 4 (80/126)

5.5 LINACS

5.5.7 Accelerating waveguide

- ❑ In the **travelling wave accelerating structure** the microwaves enter on the gun side and propagate toward the high energy end of the waveguide.
- ❑ Only one in four cavities is at any given moment suitable for acceleration.

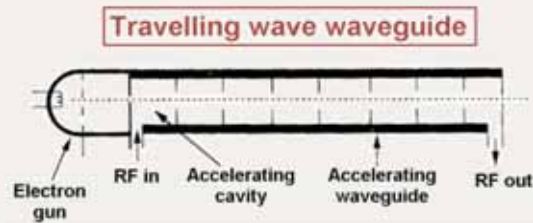

Radiation Oncology Physics: A Handbook for Teachers and Students - 5.5.7 Slide 5 (81/126)

5.5 LINACS

5.5.7 Accelerating waveguide

- ❑ In a **standing wave accelerating structure** each end of the accelerating waveguide is terminated with a conducting disk to reflect the microwave power to produce a standing wave in the waveguide.
- ❑ Every second cavity carries no electric field and thus produces no energy gain for the electron (**coupling cavities**).

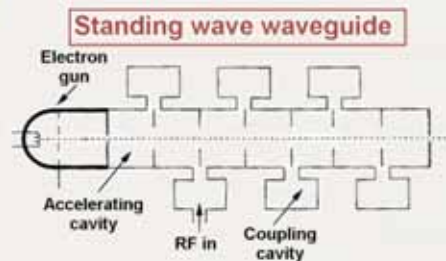

Radiation Oncology Physics: A Handbook for Teachers and Students - 5.5.7 Slide 6 (82/126)

5.5 LINACS

5.5.8 Microwave power transmission

- ❑ The **microwave power produced by the RF generator** is carried to the accelerating waveguide through rectangular uniform waveguides usually pressurized with a dielectric gas (Freon or sulfur hexafluoride SF₆).
- ❑ Between the RF generator and the accelerating waveguide is a **circulator (isolator)** which transmits the RF power from the RF generator to the accelerating waveguide but does not transmit microwaves in the opposite direction.



Radiation Oncology Physics: A Handbook for Teachers and Students - 5.5.8 Slide 1 (83/126)

5.5 LINACS

5.5.9 Auxiliary system

- ❑ **Auxiliary service** consists of four systems that are not directly involved with electron acceleration:
 - **Vacuum pumping system** producing high vacuum in the accelerating waveguide.
 - **Water cooling system** for cooling the accelerating waveguide, target, circulator and RF generator.
 - **Air pressure system** for pneumatic movement of the target and other beam shaping components.
 - **Shielding against leakage radiation** produced by target, beam transport system and RF generator.



Radiation Oncology Physics: A Handbook for Teachers and Students - 5.5.9 Slide 1 (84/126)

5.5 LINACS

5.5.10 Electron beam transport

- ❑ In medium-energy and high-energy linacs an **electron beam transport system** is used to transport electrons from the accelerating waveguide to:
 - X-ray target in x-ray beam therapy
 - Beam exit window in electron beam therapy
- ❑ Beam transport system consists of:
 - Drift tubes
 - Bending magnets
 - Steering coils
 - Focusing coils
 - Energy slits



Radiation Oncology Physics: A Handbook for Teachers and Students - 5.5.10 Slide 1 (85/126)

5.5 LINACS

5.5.10 Electron beam transport

- ❑ Three systems for electron beam bending have been developed:
 - 90° bending
 - 270° bending
 - 112.5° (slalom) bending

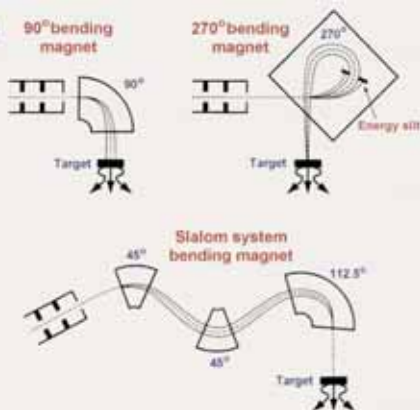

Radiation Oncology Physics: A Handbook for Teachers and Students - 5.5.10 Slide 2 (86/126)

5.5 LINACS

5.5.11 Linac treatment head

- ❑ Electrons forming the **electron pencil beam**:
 - Originate in the electron gun.
 - Are accelerated in the accelerating waveguide to the desired kinetic energy.
 - Are brought through the beam transport system into the linac treatment head.
- ❑ The clinical x-ray beams or clinical electron beams are produced in the linac treatment head.



Radiation Oncology Physics: A Handbook for Teachers and Students - 5.5.11 Slide 1 (87/126)

5.5 LINACS

5.5.11 Linac treatment head

- ❑ Components of a modern **linac treatment head**:
 - Several **retractable x-ray targets** (one for each x-ray beam energy).
 - **Flattening filters** (one for each x-ray beam energy).
 - **Scattering foils** for production of clinical electron beams.
 - **Primary collimator**.
 - Adjustable **secondary collimator** with independent jaw motion.
 - **Dual transmission ionization chamber**.
 - **Field defining light and range finder**.
 - **Retractable wedges**.
 - **Multileaf collimator (MLC)**.



Radiation Oncology Physics: A Handbook for Teachers and Students - 5.5.11 Slide 2 (88/126)

5.5 LINACS

5.5.11 Linac treatment head

- ❑ **Clinical x-ray beams** are produced with:
 - Appropriate x-ray target.
 - Appropriate flattening filter.
- ❑ **Clinical electron beams** are produced by:
 - Either scattering the pencil electron beam with an appropriate scattering foil.
 - Or deflecting and scanning the pencil beam magnetically to cover the field size required for electron treatment.
- ❑ The flattening filters and scattering foils are mounted on a rotating carousel or sliding drawer.



Radiation Oncology Physics: A Handbook for Teachers and Students - 5.5.11 Slide 3 (89/126)

5.5 LINACS

5.5.11 Linac treatment head

- ❑ **Electrons:**
 - Originate in the electron gun.
 - Are accelerated in the accelerating waveguide to the desired kinetic energy.
 - Are brought through the beam transport system into the linac treatment head.
- ❑ **The clinical x-ray beams and clinical electron beams are produced in the linac treatment head.**



Radiation Oncology Physics: A Handbook for Teachers and Students - 5.5.11 Slide 4 (90/126)

5.5 LINACS

5.5.12 Production of clinical x-ray beams

□ Megavoltage clinical x-ray beams:

- Are produced in a linac x-ray target.
- Are flattened with a flattening filter.

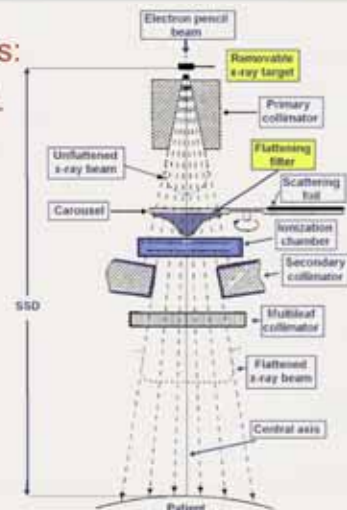

Radiation Oncology Physics: A Handbook for Teachers and Students - 5.5.12 Slide 1 (91/126)

5.5 LINACS

5.5.12 Production of clinical x-ray beams

□ Typical electron pulses arriving on the x-ray target of a linac.

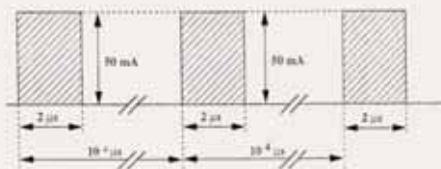

Typical values:

- Pulse height: 50 mA
- Pulse duration: 2 μ s
- Repetition rate: 100 pps
- Period: 10^4 μ s

□ The target is insulated from ground, acts as a Faraday cup, and allows measurement of the electron charge striking the target.



Radiation Oncology Physics: A Handbook for Teachers and Students - 5.5.12 Slide 2 (92/126)

5.5 LINACS

5.5.13 Beam collimation

- ❑ In modern linacs the **x-ray beam collimation** is achieved with three collimation devices:
 - Primary collimator.
 - Secondary adjustable beam defining collimator (independent jaws).
 - Multileaf collimator (MLC).

- ❑ The **electron beam collimation** is achieved with:
 - Primary collimator.
 - Secondary collimator.
 - Electron applicator (cone).
 - Multileaf collimator (under development).



Radiation Oncology Physics: A Handbook for Teachers and Students - 5.5.13 Slide 1 (93/126)

5.5 LINACS

5.5.14 Production of clinical electron beam

- ❑ To activate the **electron mode** the x-ray target and flattening filter are removed from the electron pencil beam.

- ❑ Two techniques for producing clinical electron beams from the pencil electron beam:
 - **Pencil beam scattering** with a scattering foil (thin foil of lead).
 - **Pencil beam scanning** with two computer controlled magnets.

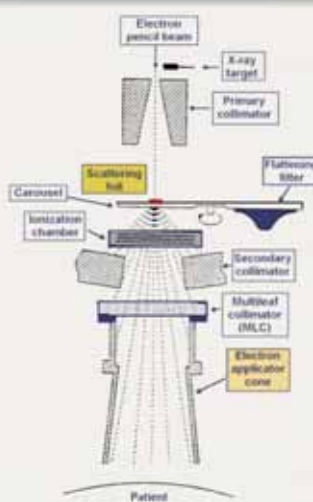

Radiation Oncology Physics: A Handbook for Teachers and Students - 5.5.14 Slide 1 (94/126)

5.5 LINACS

5.5.15 Dose monitoring system

- ❑ To protect the patient, the standards for dose monitoring systems in clinical linacs are very stringent.
- ❑ The standards are defined for:
 - Type of radiation detector.
 - Display of monitor units.
 - Methods for beam termination.
 - Monitoring the dose rate.
 - Monitoring the beam flatness.
 - Monitoring beam energy.
 - Redundancy systems.



Radiation Oncology Physics: A Handbook for Teachers and Students - 5.5.15 Slide 1 (95/126)

5.5 LINACS

5.5.15 Dose monitoring system

- ❑ **Transmission ionization chambers** are permanently embedded in linac clinical x-ray and electron beams and are the most common dose monitors in linacs.
- ❑ Linac transmission ionization chamber consists of two **separately sealed ionization chambers** with completely independent biasing power supplies and readout electrometers for increased patient safety.

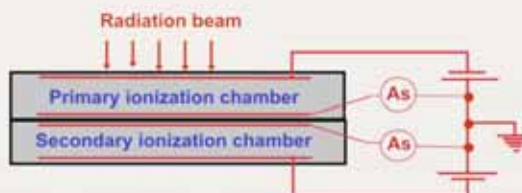

Radiation Oncology Physics: A Handbook for Teachers and Students - 5.5.15 Slide 2 (96/126)

5.5 LINACS

5.5.15 Dose monitoring system

- ❑ Most linac transmission ionization chambers are **permanently sealed**, so that their response is not affected by ambient air temperature and pressure.
- ❑ The customary position for the transmission ionization chamber is between the flattening filter (for x-ray beams) or scattering foil (for electron beams) and the secondary collimator.



Radiation Oncology Physics: A Handbook for Teachers and Students - 5.5.15 Slide 3 (97/126)

5.5 LINACS

5.5.15 Dose monitoring system

- ❑ The primary transmission ionization chamber measures **the monitor units (MUs)**.
- ❑ Typically, the sensitivity of the primary chamber electrometer is adjusted in such a way that:
 - 1 MU corresponds to a dose of 1 cGy
 - delivered in a water phantom at the depth of dose maximum
 - on the central beam axis when
 - for a 10x10 cm² field
 - at a source-surface distance (SSD) of 100 cm.



Radiation Oncology Physics: A Handbook for Teachers and Students - 5.5.15 Slide 4 (98/126)

5.5 LINACS

5.5.15 Dose monitoring system

- ❑ Once the operator preset number of MUs has been reached, the primary ionization chamber circuitry:
 - Shuts the linac down.
 - Terminates the dose delivery to the patient.
- ❑ Before a new irradiation can be initiated:
 - MU display must be reset to zero.
 - Irradiation is not possible until a new selection of MUs and beam mode has been made.



Radiation Oncology Physics: A Handbook for Teachers and Students - 5.5.15 Slide 5 (99/126)

5.6 RADIOTHERAPY WITH PROTONS, NEUTRONS

- ❑ External beam radiotherapy is carried out mainly with machines that produce either x-rays or electrons.
- ❑ In a few specialized centres around the world, external beam radiotherapy is also carried out with heavier particles, such as:
 - Neutrons produced by cyclotrons or neutron generators
 - Protons produced by cyclotrons or synchrotrons
 - Heavy ions (helium, carbon, nitrogen, argon, neon) produced by synchrocyclotrons or synchrotrons.



Radiation Oncology Physics: A Handbook for Teachers and Students - 5.6 Slide 1 (100/126)

5.6 RADIOTHERAPY WITH PROTONS AND NEUTRONS

- Percentage depth dose against depth in water for radiation beams of various types and energies:

- (a) Photons
- (b) Neutrons
- (c) Electrons
- (d) Heavy charged particles

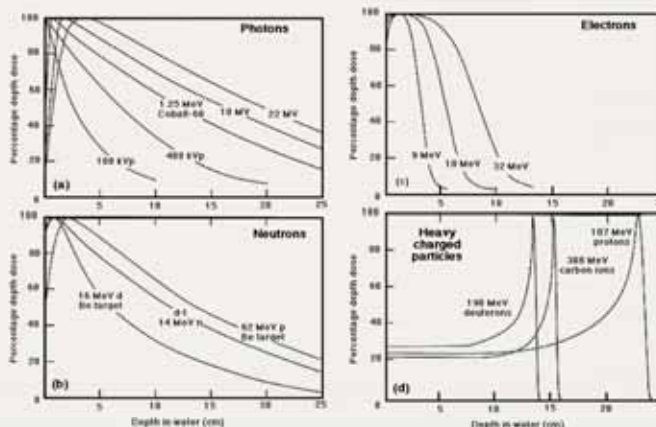

Radiation Oncology Physics: A Handbook for Teachers and Students - 5.6 Slide 2 (101/126)

5.6 RADIOTHERAPY WITH PROTONS, NEUTRONS

- Advantages of neutron, proton and heavy charged particle beams over the standard x ray and electron modalities:
 - Lower oxygen enhancement ratio (OER) for neutrons.
 - Improved dose-volume histograms (DVHs) for protons and heavy charged particles.
- Main disadvantages of neutron, proton and heavy charge particle beams in comparison with standard x-ray and electron modalities are:
 - Considerably higher capital, maintenance and servicing cost.
 - Significantly more complex equipment design and operation.



Radiation Oncology Physics: A Handbook for Teachers and Students - 5.6 Slide 3 (102/126)

5.7 SHIELDING CONSIDERATIONS

- ❑ External beam radiotherapy is carried out mainly with three types of equipment that produces either x rays or electrons for clinical use:
 - X-ray machines (superficial or orthovoltage).
 - Cobalt-60 teletherapy machines.
 - Linacs.
- ❑ All radiotherapy equipment must be housed in specially shielded treatment rooms in order to protect personnel and general public in areas adjacent to the treatment rooms.



Radiation Oncology Physics: A Handbook for Teachers and Students - 5.7 Slide 1 (103/126)

5.7 SHIELDING CONSIDERATIONS

- ❑ Treatment rooms must comply:
 - Not only with structural building codes
 - But also with national and international regulations that deal with shielding requirements to render an installation safe from the radiation protection point of view.
- ❑ During the planning stage for a radiotherapy machine installation, a qualified medical physicist:
 - Determines the required thickness of primary and secondary barriers
 - Provides the information to the architect and structural engineer for incorporation into the architectural drawing for the treatment room.



Radiation Oncology Physics: A Handbook for Teachers and Students - 5.7 Slide 2 (104/126)

5.7 SHIELDING CONSIDERATIONS

- ❑ Superficial and orthovoltage x-ray therapy rooms are shielded:
 - Either with ordinary concrete (density: 2.35 g/cm^3)
 - Or lead (density: 11.36 g/cm^3 , atomic number: 82).
- ❑ In this energy range the photoelectric effect is the predominant mode of photon interaction with matter, making the use of lead very efficient for shielding purposes.



Radiation Oncology Physics: A Handbook for Teachers and Students - 5.7 Slide 3 (105/126)

5.7 SHIELDING CONSIDERATIONS

- ❑ Megavoltage treatment rooms are often referred to as bunkers or vaults because of the large primary and secondary barrier thicknesses required for shielding.
 - Megavoltage bunkers are most commonly shielded with ordinary concrete so as to minimize construction cost.
 - The Compton effect is the predominant mode of photon interaction with shielding material in the megavoltage energy region. The barrier thickness is thus scaled inversely with density of the shielding material.



Radiation Oncology Physics: A Handbook for Teachers and Students - 5.7 Slide 4 (106/126)

5.8 COBALT-60 TELETHERAPY UNITS VERSUS LINACS

- ❑ Cobalt-60 teletherapy unit, developed in Canada in the 1950s, was the first truly practical megavoltage therapy machine.
- ❑ The important features of a teletherapy source are:
 - Relatively high energy gamma ray emission.
 - Relatively long half-life.
 - Relatively high specific activity.
 - Relatively high specific air kerma rate constant.
 - Relatively simple means of production.



Radiation Oncology Physics: A Handbook for Teachers and Students - 5.8 Slide 1 (107/126)

5.8 COBALT-60 TELETHERAPY UNITS VERSUS LINACS

- ❑ Typical cobalt-60 teletherapy installation: isocentric machine
 - Primary barriers shield against the primary cobalt-60 beam.
 - Secondary barriers shield against leakage radiation and radiation scattered from the patient.

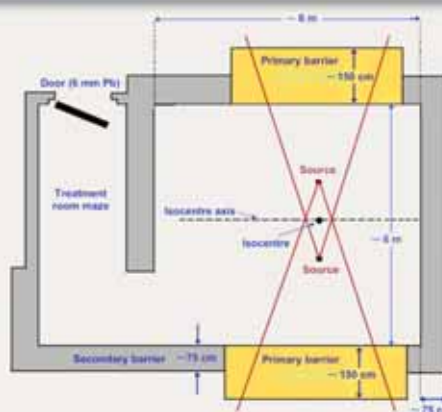

Radiation Oncology Physics: A Handbook for Teachers and Students - 5.8 Slide 2 (108/126)

5.8 COBALT-60 TELETHERAPY UNITS VERSUS LINACS

- Of the close to 300 natural nuclides and over 3000 artificially produced radionuclides, only four meet the teletherapy source requirements (Co-60, Cs-137, Eu-152, and Ra-226) and only cobalt-60 is actually used in practice.

Radionuclide	Co-60	Cs-137	Eu-152	Ra-226
Half-life (y)	5.26	30	13.4	1600
Energy (MeV)	1.25, 1.33	0.660	0.6-1.4	0.18-2.2
Specific activity (Ci/g)	1130(300)	80	180(150)	0.988
Γ_{AKR} [$\mu\text{Gy} \cdot \text{m}^2 / (\text{GBq} \cdot \text{h})$]	309	78	250	194
Means of production	$^{59}\text{Co} + n$ in reactor	Fission by-product	$^{151}\text{Eu} + n$ in reactor	Natural ^{238}U series



Radiation Oncology Physics: A Handbook for Teachers and Students - 5.8 Slide 3 (109/126)

5.8 COBALT-60 TELETHERAPY UNITS VERSUS LINACS



Radiation Oncology Physics: A Handbook for Teachers and Students - 5.8 Slide 4 (110/126)

5.8 COBALT-60 TELE THERAPY UNITS VERSUS LINACS

- ❑ Both the cobalt-60 teletherapy machine and clinical linac were introduced in the 1950s and used for megavoltage radiotherapy since then.
- ❑ During the past 50 years:
 - The basic design of the cobalt machine remained essentially the same.
 - Linac progressed to the current design through five generations, eclipsed the cobalt machine, and became the most widely used radiation source in modern radiotherapy, with several 1000 units in clinical practice around the world today.



Radiation Oncology Physics: A Handbook for Teachers and Students - 5.8 Slide 5 (11/126)

5.8 COBALT-60 TELE THERAPY UNITS VERSUS LINACS

- ❑ In comparison with cobalt-60 teletherapy machines linacs have become very complex in design:
 - Because of the **multimodality capabilities** that have evolved and are available on most modern linacs (several x-ray energies and several electron energies).
 - Because of an increased use of **computer logic and micro-processors** in the control systems of linacs.
 - Because of **added features**, such as high dose rate modes, multileaf collimation, electron arc therapy, and the dynamic treatment option on the collimators (dynamic wedge), MLC leaves (IMRT), gantry or table while the beam is turned on.



Radiation Oncology Physics: A Handbook for Teachers and Students - 5.8 Slide 6 (11/126)

5.8 COBALT-60 TELETHERAPY UNITS VERSUS LINACS

- ❑ Despite clear technological and practical advantages of linacs over cobalt-60 machines, the latter still occupy an important place in radiotherapy armamentarium, especially in developing countries, because of:
 - Their considerably lower capital and installation cost.
 - Lower servicing and maintenance cost.
 - Lesser dependence on reliable electrical power.
 - Simplicity of design.
 - Ease of operation.



Radiation Oncology Physics: A Handbook for Teachers and Students - 5.8 Slide 7 (113/126)

5.9 SIMULATORS AND CT SIMULATORS

- ❑ Simulators and CT simulators cover several important steps in the radiotherapeutic process related to:
 - Determination of target location within the patient.
 - Determination of the target shape and volume.
 - Determination of the location of critical structures adjacent to treatment volume.
 - Planning of dose delivery procedure (treatment planning).
 - Accuracy of dose delivery to the target.



Radiation Oncology Physics: A Handbook for Teachers and Students - 5.9 Slide 1 (114/126)

5.9 SIMULATORS AND CT SIMULATORS

5.9.1 Radiotherapy simulator

- ❑ Radiotherapy simulator consists of a **diagnostic x-ray tube**
 - mounted on a **rotating gantry**
 - to simulate geometries of isocentric teletherapy machines and isocentric linacs.



Radiation Oncology Physics: A Handbook for Teachers and Students - 5.9.1 Slide 1 (115/126)

5.9 SIMULATORS AND CT SIMULATORS

5.9.1 Radiotherapy simulator

- ❑ The simulator enjoys the same degrees of freedom as a megavoltage therapy machine, however:
- ❑ Rather than providing a megavoltage beam for dose delivery it provides a diagnostic quality x-ray beam suitable for:
 - Planar imaging (**fluoroscopy and radiography**).
 - **Cone beam CT**.



Radiation Oncology Physics: A Handbook for Teachers and Students - 5.9.1 Slide 2 (116/126)

5.9 SIMULATORS AND CT SIMULATORS

5.9.1 Radiotherapy simulator

- ❑ In megavoltage machines, radiation fields are defined with collimators (upper and lower jaws).
- ❑ In simulators radiation fields (square and rectangular) are indicated with **delineator wires** while the radiation field, defined with a collimator, provides a field that exceeds in size the delineated field to enable visualization of the target as well as healthy tissues adjacent to the target.



Radiation Oncology Physics: A Handbook for Teachers and Students - 5.9.1 Slide 3 (117/126)

5.9 SIMULATORS AND CT SIMULATORS

5.9.1 Radiotherapy simulator

- ❑ **Modern simulator covers the following processes:**
 - Tumour and adjacent normal tissue localization.
 - Treatment simulation.
 - Treatment plan verification.
 - Monitoring of treatment.
- ❑ The design specifications and quality assurance processes for a simulator cover four distinct components:
 - Mechanical motions.
 - Electrical.
 - X-ray tube and generator.
 - Image detection.



Radiation Oncology Physics: A Handbook for Teachers and Students - 5.9.1 Slide 4 (118/126)

5.9 SIMULATORS AND CT SIMULATORS

5.9.2 CT simulator

- ❑ **CT simulators** are CT scanners equipped with special features dedicated to the radiotherapy process, such as:
 - **Flat table top** surface to provide a patient position during simulation that will be identical to the position during treatment on a megavoltage machine.
 - **Laser marking system** to transfer the coordinates of the tumour isocentre to the surface of the patient.
 - **Virtual simulator** consisting of software packages to allow the user to define and calculate a treatment isocentre and then simulate a treatment using digitally reconstructed radiographs (DRRs).



Radiation Oncology Physics: A Handbook for Teachers and Students - 5.9.2 Slide 1 (119/126)

5.9 SIMULATORS AND CT SIMULATORS

5.9.2 CT simulator

- ❑ **Oncology CT simulator (Philips)**
- ❑ **Bore opening: 85 cm**
- ❑ **Flat table top**



Radiation Oncology Physics: A Handbook for Teachers and Students - 5.9.2 Slide 2 (120/126)

5.9 SIMULATORS AND CT SIMULATORS

5.9.2 CT simulator

The major steps in the target localization and field design are:

- Physical simulation
 - (1) Acquisition of the patient data set.
 - (2) Localization of target and adjacent structures.
 - (3) Definition and marking of the patient coordinate system.
- Virtual simulation
 - (1) Design of treatment fields.
 - (2) Transfer of data to the treatment planning system (TPS).
 - (3) Production of images used for treatment verification.



Radiation Oncology Physics: A Handbook for Teachers and Students - 5.9.2 Slide 3 (121/126)

5.9 SIMULATORS AND CT SIMULATORS

5.9.2 CT simulator

CT simulation process:

- The patient data set is collected and target localization is carried out using CT axial images.
- Laser alignment system is used for marking.
- Virtual simulator software package is used for field design and production of verification images (DRRs).
- Transfer of patient data to the treatment planning system (TPS) is achieved electronically.



Radiation Oncology Physics: A Handbook for Teachers and Students - 5.9.2 Slide 4 (122/126)

5.9 SIMULATORS AND CT SIMULATORS

5.9.2 CT simulator

- ❑ Digitally reconstructed radiograph (DRR) is the digital equivalent of a planar simulation x-ray film.
- ❑ DRR is reconstructed from a CT data set using virtual simulation software available on CT simulator or on TPS
 - DRR represents a computed radiograph of a virtual patient generated from a CT data set representing the actual patient.
 - Like a conventional radiograph, the DRR accounts for beam divergence.



Radiation Oncology Physics: A Handbook for Teachers and Students - 5.9.2 Slide 5 (123/126)

5.9 SIMULATORS AND CT SIMULATORS

5.9.2 CT simulator

- ❑ Steps involved in producing a DRR:
 - Choice of virtual source position.
 - Definition of image plane.
 - Ray tracing from virtual source to image plane.
 - Determination of the CT value for each volume element traversed by the ray line to generate an effective transmission value at each pixel of the image plane.
 - Summation of CT values along the ray line (line integration).
 - Grey scale mapping.



Radiation Oncology Physics: A Handbook for Teachers and Students - 5.9.2 Slide 6 (124/126)

5.9 SIMULATORS AND CT SIMULATORS

5.9.2 CT simulator

Typical DRR



Radiation Oncology Physics: A Handbook for Teachers and Students - 5.9.2 Slide 7 (125/126)

5.10 TRAINING REQUIREMENTS

Considerations of vital importance in the purchase, installation, and clinical operation of modern radiotherapy equipment:

- Preparation of an equipment specification document.
- Design of the treatment room and radiation safety.
- Acceptance testing of the equipment.
- Commissioning of equipment.
- Quality assurance programme.



Radiation Oncology Physics: A Handbook for Teachers and Students - 5.10 Slide 1 (126/126)